

BATTERY UVC LED DISINFECTION BOX

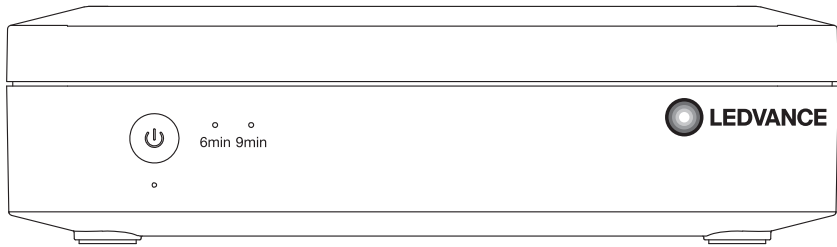

	EAN	W	Δ (°C)	V~	A	nm	mW	Mode	Port
BATTERY UVC LED DISINFECTION BOX	4058075515994	5	-20 - +40	5	1	270-280	4x4	4 x UVC-LED	Type-C USB

BATTERY UVC LED DISINFECTION BOX

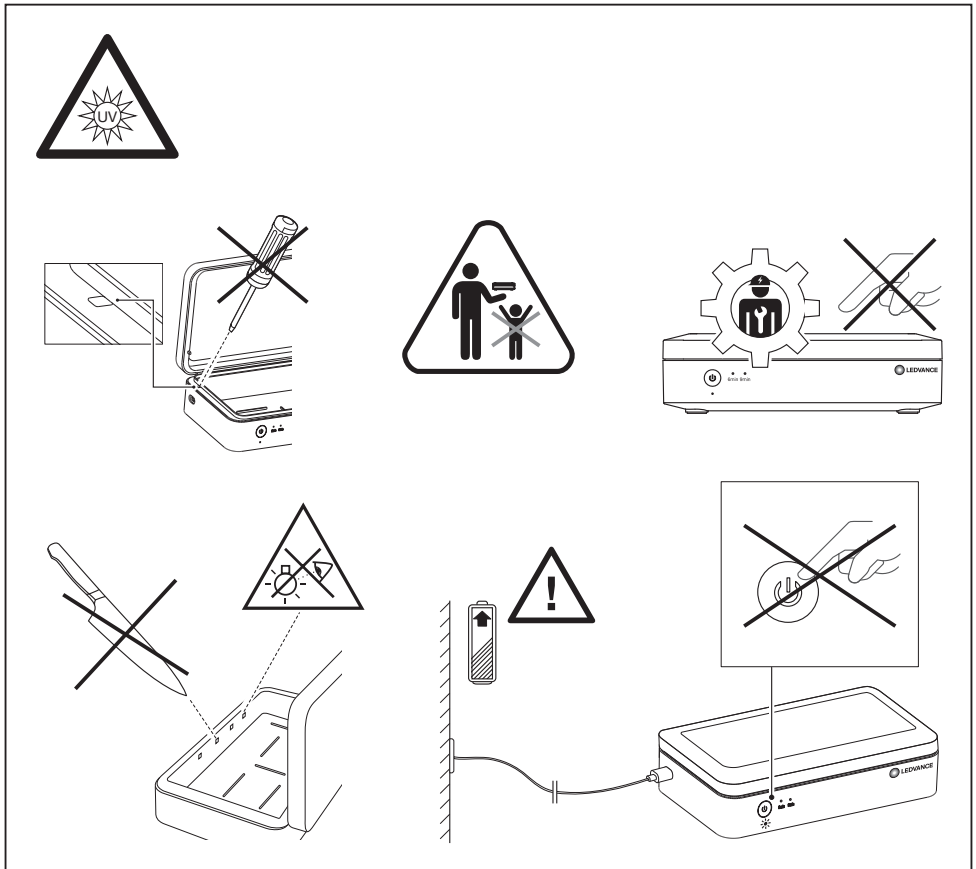
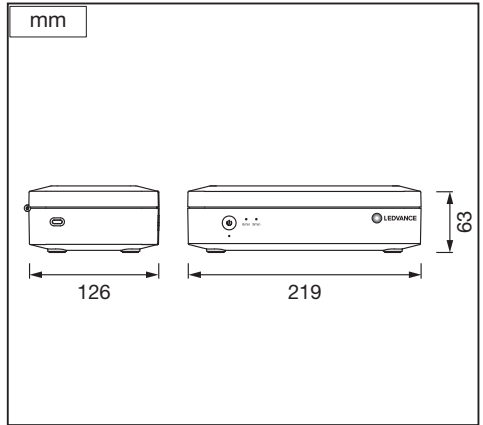
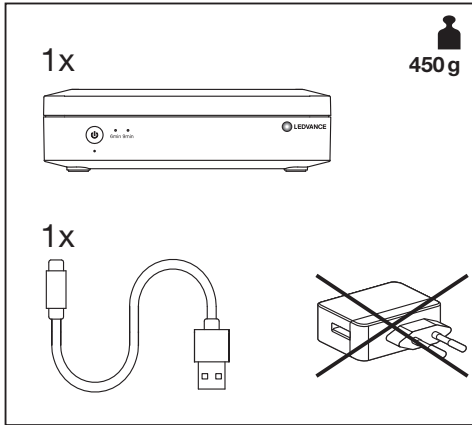
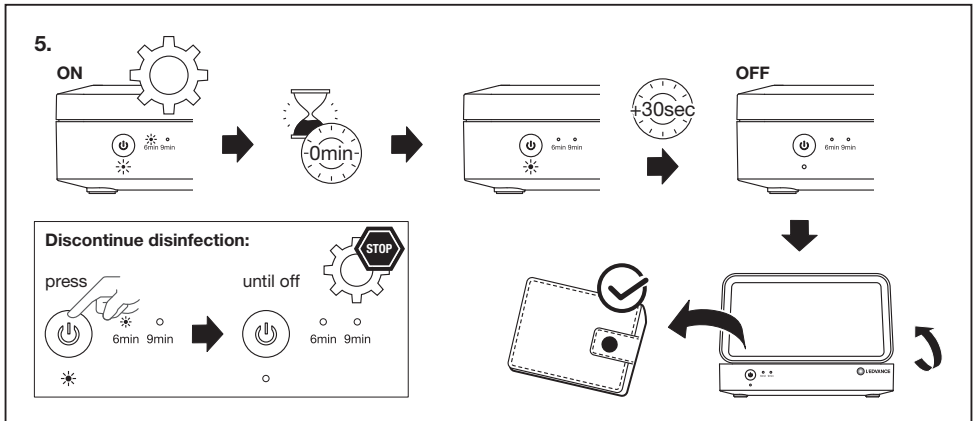
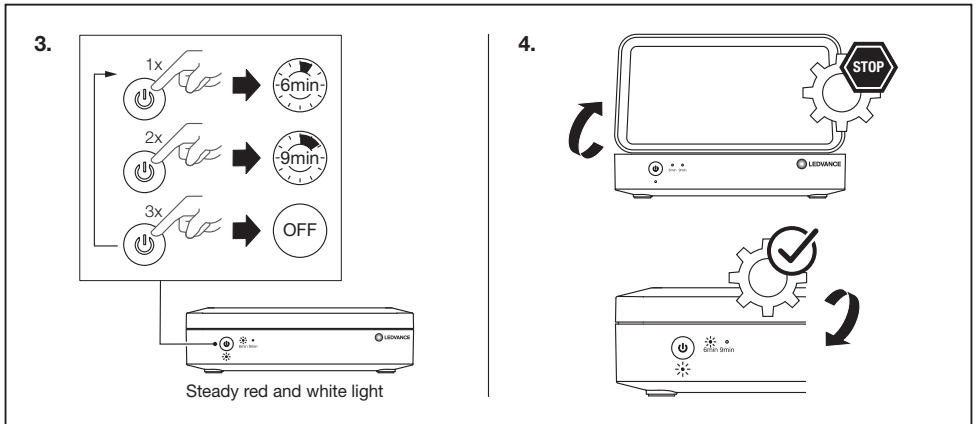
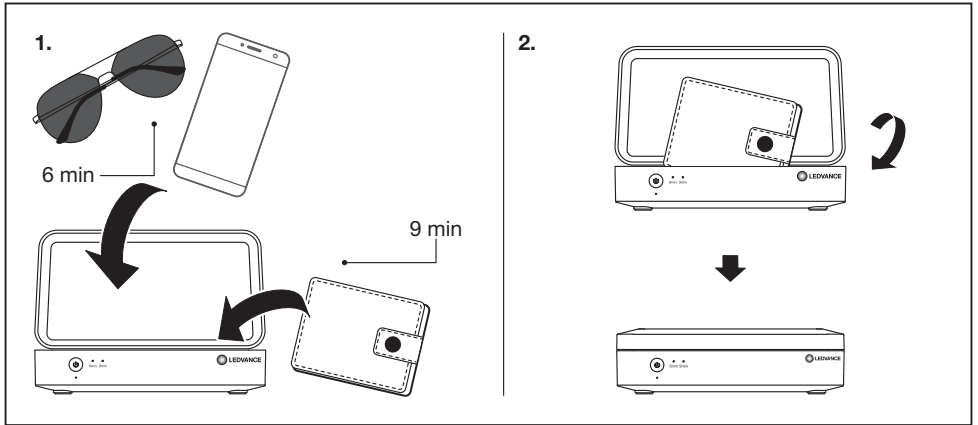



Battery/Charging

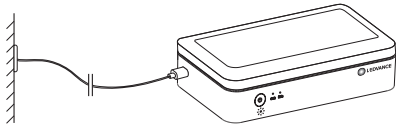

Max. 25x

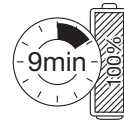

Max. 16x

Flashing green light:



Flashing red light:



Steady green light:

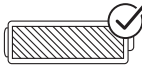

Steady red and white light:



UVC Disinfection of Some Common Bacteria

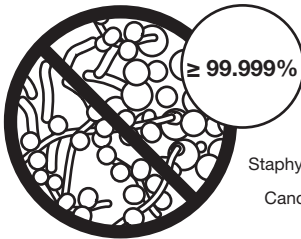

Escherichia coli
Staphylococcus aureus
Candidiasis albicans*



UVC RISK GROUP: EXEMPT

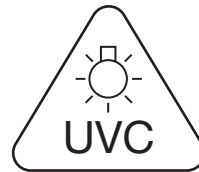

ⓘ Dies ist kein medizinisches Gerät. ⓘ This is not a medical device. ⓘ Ceci n'est pas un dispositif médical. ⓘ Questo non è un dispositivo medico. ⓘ Este no es un dispositivo médico ⓘ Este não é um dispositivo médico. ⓘ Αυτό το προϊόν δεν είναι ιατρική συσκευή. ⓘ Dit is geen medische apparatuur. ⓘ Detta är inte någon medicinsk utrustning. ⓘ Tämä ei ole lääkintälaitte. ⓘ Dette er ingen medisinsk enhet. ⓘ Dette er ikke medicinsk udstyr. ⓘ Toto není zdravotnický prostředek. ⓘ Ὁτο не медицинское изделие. ⓘ A termék nem orvostechnikai eszköz. ⓘ Ten produkt nie jest wyrobem medycznym. ⓘ Toto nie je zdravotnícka pomôcka. ⓘ То ni медицински припоmocёк. ⓘ Bu ürün tibbi bir cihaz deđildir. ⓘ Ovo nije medicinski proizvod. ⓘ Acesta nu este un dispozitiv medical. ⓘ Това не е медицинско изделие. ⓘ See ei ole meditsiiniseade. ⓘ Tai nėra medicinos priemonė. ⓘ Št nav medicinska ierice. ⓘ Ovo nije medicinsko sredstvo. ⓘ Це не медицинский вирiб. ⓘ Бул – медициналык кyрылгы емес.



C10449057
G11117143
31.03.2021



LEDVANCE GmbH
Steinerne Furt 62
86167 Augsburg, Germany
www.ledvance.com